

## Lineup of two print table sizes to match the application and standard substrate size

**JFX600-2513** table size  
2,500mm x 1,300mm

General-purpose size for sign graphics materials, full-size prints on 4'x8' boards

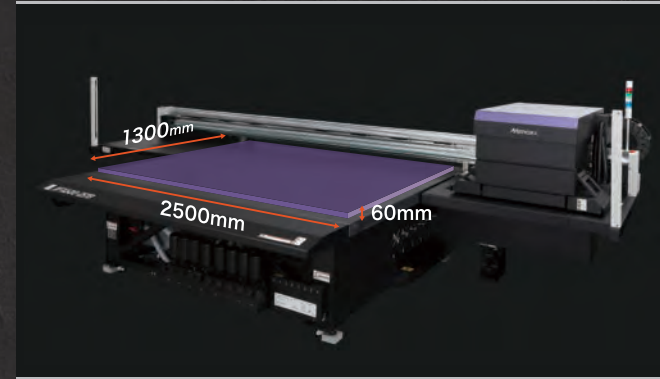

**JFX600-2531** table size  
2,500mm x 3,100mm

Supports architectural material printing - glass, partitions and plywood

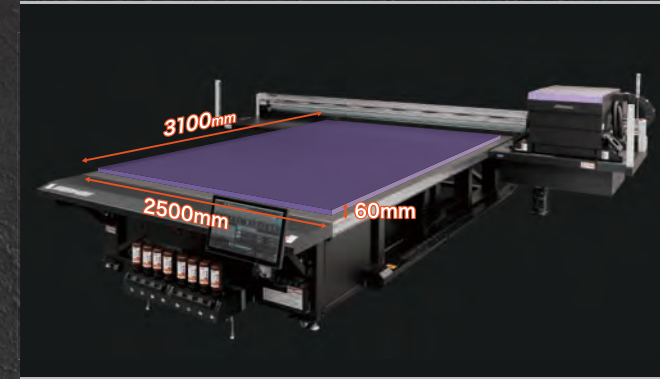

**Vacuum table** Vacuum area partitioning for efficiency of media sets of various sizes

**JFX600-2513**

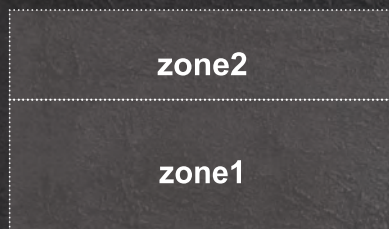

Vacuum zone valves



Foot switch

The vacuum area to hold media is divided into two sections in the X direction of the table, and can be adjusted to the media size you use by opening/closing valves. Besides the operation panel, a foot switch can be used to turn the vacuum on and off.

**JFX600-2531**



**JFX600-2531** supports

### Toggle Print Function

Two print origin points are set at the front and rear of the print table to minimize printer stand-by time by replacing the media on the rear side of the table while printing is being done on the front side.

Contributes to increase production efficiency. The maximum print size for the Front/Rear side during toggle printing is 2513 (2,500 x 1,300 mm).

**FF (Front/Front) Method**

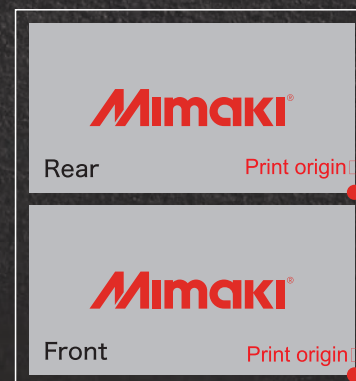

**FR (Front/Rear) Method**



### Specifications

Item	JFX600-2513	JFX600-2531	
Head	On-demand piezo head		
	16 printheads arranged in 4 staggered lines for 4 heads		
Print resolution	600 dpi, 1200 dpi		
Ink	Type	Hard UV-curable ink LH-100	
	Supply system	Flexible UV-curable ink LUS-120/LUS-150/LUS-211 <sup>1)</sup>	
	Ink circulation system	White ink circulation using MCT (Mimaki Circulation Technology) <sup>2)</sup>	
Maximum printable area (W x D)	2,500 x 1,300 mm (98.4 x 51.2")	2,500 x 3,100 mm (98.4 x 122.0")	
	Media	Up to 2,500 x 1,300 mm (98.4 x 51.2")	
Media absorption	Size (W x D)	Up to 2,500 x 3,100 mm (98.4 x 122.0")	
	Height	60 mm (2.4") or less	
	Weight	50 kg/m <sup>2</sup> (110.2 lb/ft <sup>2</sup> ) or less	
Media absorption	Blower absorption type + foot switch		
Absorbing area division number	Divided into 2	Divided into 9	
UV unit	LED-UV system		
Interface	Ethernet 10GBASE-T		
Certifications	CE Mark (EMC Directive, Machinery Directive), UL775, RoHS, EAC, UKCA, RCM		
Power supply	(200-240VAC ±10% 50/60Hz ±1Hz, 24A) x 3		
Power consumption	INLET1-3, each INLET: 4,800W or less		
Operation environment	Temperature	20 - 30°C (68-86°F)	
	Humidity	35 to 65% RH (No condensation)	
	Guaranteed accuracy temperature	20 - 25°C (68-77°F)	
	Temperature gradient	±10°C/h or less	
	Dust level	0.15mg/m <sup>3</sup> (Equivalent to a general office floor level)	
External dimensions (W x D x H)	Approx. 5,300 x 2,850 x 1,700 mm or less (208.7 x 112.2 x 66.9")	Approx. 5,400 x 4,850 x 1,700 mm or less (212.6 x 190.9 x 66.9")	
	Weight	Approx. 1,200 kg (2,645.5 lb) or less	Approx. 1,600 kg (3,527.4 lb) or less

<sup>1)</sup> The stretchability of flexible ink varies depending on the printing material. Please be sure to do a test print beforehand.  
<sup>2)</sup> MCT works only with white ink.

### Supplies

Item	Color	Item No.	Remarks		
LH-100 GREENGUARD Gold certified ink	Cyan	LH100-C-BA			
	Magenta	LH100-M-BA			
	Yellow	LH100-Y-BA			
	Black	LH100-K-BA			
	Light Cyan	LH100-LC-BA			
	Light Magenta	LH100-LM-BA			
	White	LH100-W-BA			
	Clear	LH100-CL-BA			
	LUS-120 GREENGUARD Gold certified ink	Cyan		LUS12-C-BA	Ink package:1L bottle
		Magenta		LUS12-M-BA	
Yellow		LUS12-Y-BA			
Black		LUS12-K-BA			
Light Cyan		LUS12-LC-BA			
Light Magenta		LUS12-LM-BA			
White		LUS12-W-BA			
Clear		LUS12-CL-BA			
LUS-150 <sup>1)</sup> GREENGUARD Gold certified ink		Cyan	LUS15-C-BA		
		Magenta	LUS15-M-BA		
	Yellow	LUS15-Y-BA			
	Black	LUS15-K-BA			
	Light Cyan	LUS15-LC-BA			
	Light Magenta	LUS15-LM-BA			
	White	LUS15-W-BA			
	Clear	LUS15-CL-BA			
	LUS-211 <sup>2)</sup> GREENGUARD Gold certified ink	Cyan	LUS211-C-BA		
		Magenta	LUS211-M-BA		
Yellow		LUS211-Y-BA			
Black		LUS211-K-BA			
White		LUS211-W-BA			
Clear	LUS211-CL-BA				
Primer	PR-200 <sup>3)</sup>	PR200-Z-BA			

<sup>1)</sup> If you use CL in the LUS-150 ink set, please use the CL of LH-100.  
<sup>2)</sup> LUS-211 ink is available in some regions.  
<sup>3)</sup> The PR-200 is not compatible with LUS-211.

Some of the samples in this catalog are artificial renderings. • Specifications, design and dimensions stated in this catalog may be subject to change without notice (for technical improvements, etc.). • The corporate names and merchandise names written on this catalog are the trademark or registered trademark of the respective corporations. • Inkjet printers print using extremely fine dots, so colors may vary slightly after replacement of the printing heads. Also note that if using multiple printer units, colors could vary slightly from one unit to other unit due to slight individual differences. • The specifications described in this catalog are as of April 2024.



MIMAKI EUROPE BV

Stammerdijk 7E, 1112 AA Diemen, The Netherlands  
www.mimakieurope.com | Tel. : +31 20 4627640  
@MimakiEurope

### Installation space

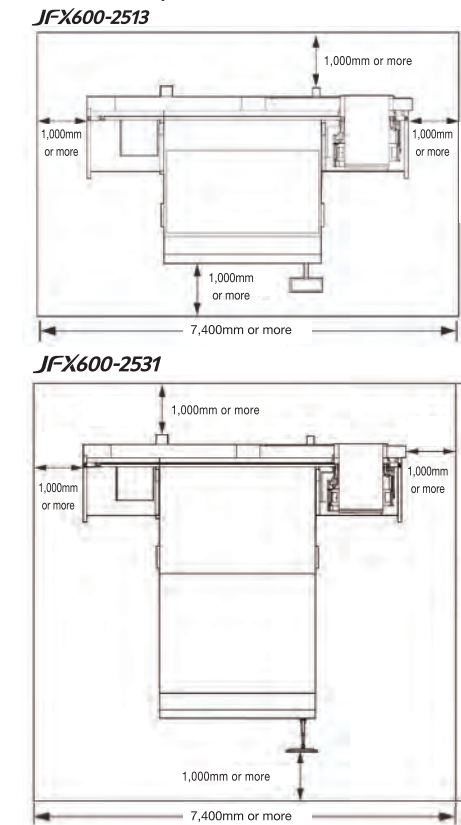

### Options

Item code	Item	Remarks
OPT-J0534	3L Ink supply option	For JFX600-2513 model
OPT-J0527	Ionizer kit	Static eliminator kit
OPT-J0216	Vacuum unit (φ3mm×200mm) (φ 0.1 in.×7.9 in.)	Three-phase, 200 V-240 V, 30 A, 3.4kW
OPT-J0217	Vacuum unit (φ1mm×200mm) (φ 0.04 in.×7.9 in.)	Single-phase, 200 V-240 V, 30 A, 1.9kW
OPT-J0232	Vacuum unit (φ3mm×400mm) (φ 0.1 in.×15.7 in.)	Three-phase, 380 V-480 V, 20 A, 3.4kW
OPT-J0348	Optional blower connector kit	Necessary for connecting an optional vacuum unit For JFX600-2513 model

<sup>3</sup>L Ink supply option and Optional blower connector kit for JFX600-2531 model will be released in June 2024.

### Inks and substrates:

As physical properties of ink (adhesion, weather resistance etc.) are different depending on media, please be sure to have a print test in advance.  
Depending on the application, primers, other surface treatment or surface protection such as lamination may be necessary.

### Safety notice:

This product is equipped with UV irradiation equipment.  
Please pay attention to the following notes in order to use safely.  
Do not look directly into the UV light source nor place your hand, or expose your skin directly to the UV light source.  
Depending upon print mode, some VOC emission from printed parts not yet cured and hardened may occur.  
In addition, please be sure to read and follow the instructions and guidelines of the manual carefully.

For  
**INDUSTRIAL  
PRODUCTS**

Large Flatbed UV-LED Inkjet Printer

**Mimaki**

**JFX600 Series**  
JFX600-2513 / JFX600-2531



**High Productivity × High Quality**

Max. Print Speed 200 m<sup>2</sup>/h

Max. Print Resolution 1200 dpi

Max. 6 color inks



# JFX600 Series

Achieves the high-speed and high-image quality required for large format graphic printers. With a maximum print speed of 200m<sup>2</sup>/h, a maximum resolution of 1200dpi and up to 6 color ink set for unparalleled print quality, featuring 3 types of high performance UV ink to choose from. In addition, 2 table sizes are available ; a 4'x8' board size for general-purpose sign graphic applications and a standard 3-meter print size for architectural materials. This product will grow your graphics business with its operability and safety features befitting a high-speed printer.

## Amazingly high productivity

Up to Max. 330% UP

Max. 330%<sup>\*1</sup> faster than the previous model (JFX500-2131) by installing significantly more printheads. The great increase in productivity allows for quick delivery of large format prints.

\*1: Comparison between JFX Series in Draft mode(4C/600×600 dpi/2P and JFX500-2131 in Draft mode(4C/300×450 dpi/3P)

Speed comparison in the equivalent image quality, when printing at 4C / 1 layer

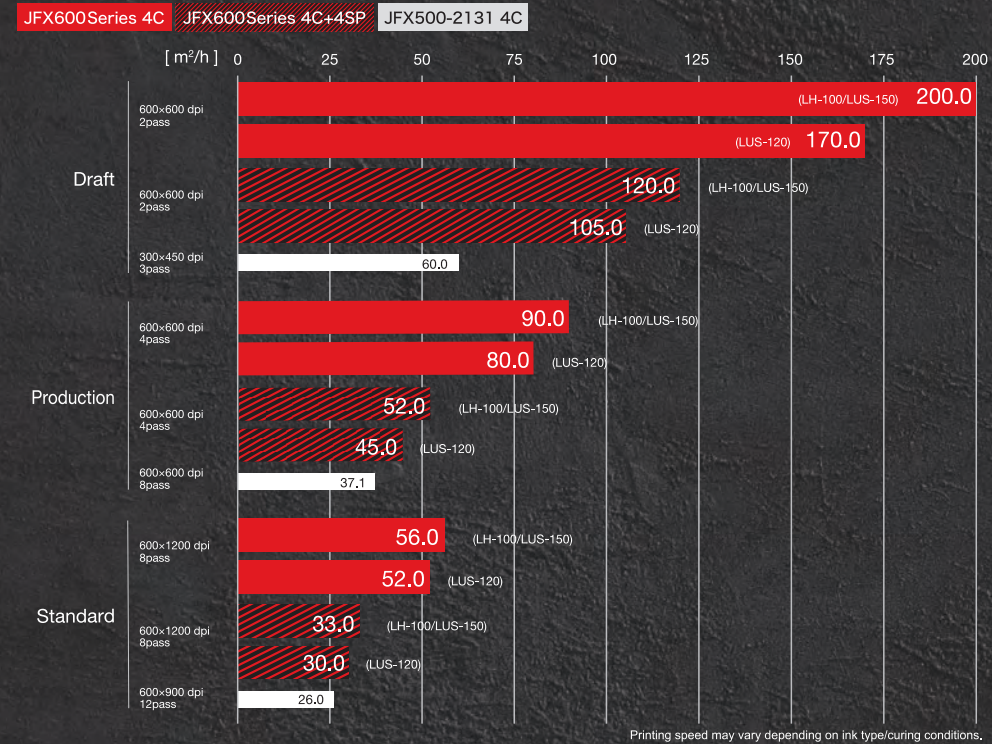

## Six colors, including light colors, are supported

Ink color sets LH-100, LUS-120, LUS-150

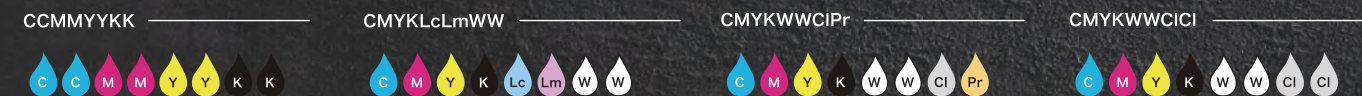

Four-color ink set for high productivity, achieving a fast print speed of 200 m<sup>2</sup>/h

Add light colors for smooth gradations, natural skin tones, and vivid photo reproduction

Use clear ink for gloss/matte finishes, embossing, and 2.5D print creating semi-stereoscopic surfaces, and primer for stronger adhesion between ink and material

Further glossiness and popped up texture can be achieved with double-clear ink printing capability.

## Mimaki's image quality control technology ensures more beautiful prints

### MAPS4 (Mimaki Advanced Pass System 4)

Banding (horizontal stripes), uneven color, and glossy streaks can be reduced to realize smooth prints by printing pass boundaries fading in gradation.



Based on printing conditions such as media/ink type and resolution, the most suitable gradation pattern is automatically selected and printed.

### Variable dots

Three different ink dot sizes are used to enable high-quality prints with reduced graininess.

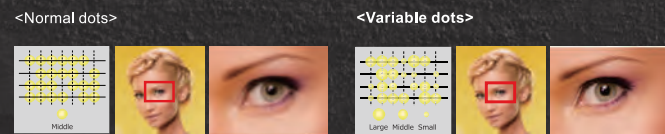

Combination of dots including the minimum size of 7µ enables grainless, smooth color printing.

## MPC using a graphical user interface

### MPC (Mimaki Printer Controller)

It is a new software used for operation in the touch screen monitor connected to the printer. All operations are visually organized by item and can be performed on the MPC screen, including setting print conditions, checking work/printer status and work history, and checking maintenance instructions.

#### Job management status

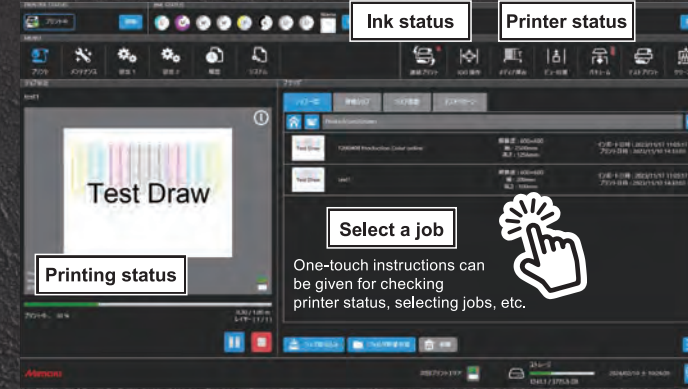

#### Printing conditions management status

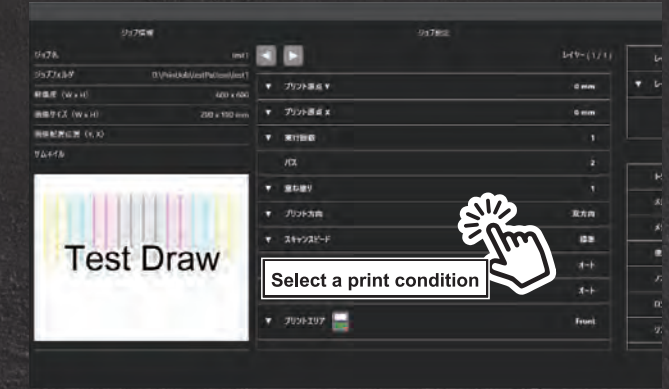

## Reliable functions for stable operation

### NCU (Nozzle Check Unit)

The sensor automatically detects the nozzle condition. When the NCU detects a missing nozzle, it automatically performs cleaning to solve the problem.

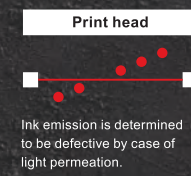

### NRS (Nozzle Recovery System)

If there is a nozzle problem that cannot be solved by cleaning, it automatically replaces the defective nozzle with an alternate one for each nozzle, which enables continuous printing without lowering printing speed.

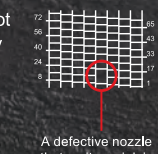

### MCT (Mimaki Circulation Technology)

An ink circulation mechanism is provided in the ink tank and ink path. It circulates white ink periodically to prevent nozzle trouble due to deposited ink pigments and to stabilize printing performance.

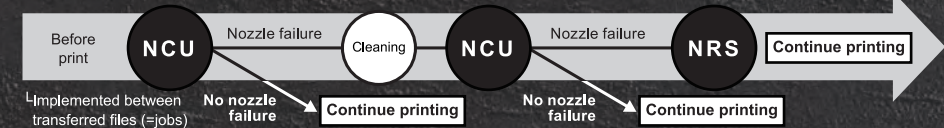
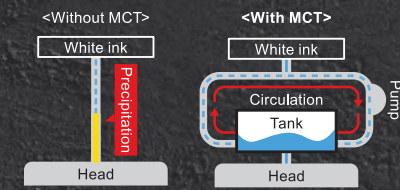

## Semi-stereoscopic 2.5D printing made easy! High value-added printing with "2.5D Texture Print" in "RasterLink7"!

### Stereoscopic appeal with 2.5D printing

A newly developed function, "2.5D Texture Print" in Mimaki's original RIP, "RasterLink7" allows you to easily create multi-layered gradation data.

The "Emboss Print", one of Mimaki's printing solutions, "Surface Imaging" makes a surface look bumpy with multi-layered UV ink printing, which requires a manual preparation of step-wise data for each layer to create smoother expression. However, "JFX200-2513EX" allows you to easily create 2.5D print data of different layer with steps, simply by using "RasterLink7" (Standard accessory) and Illustrator/Photoshop

### Feel the texture

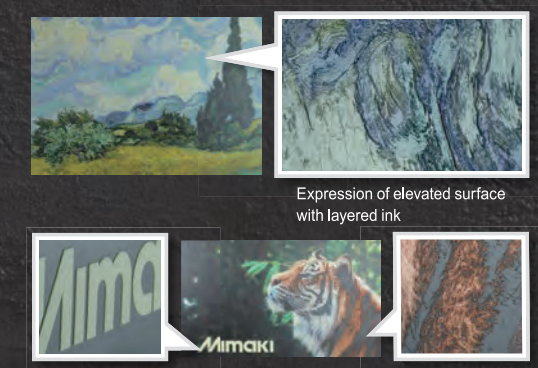

### White ink and clear ink

Printing together with high-concentration white ink as the base color on transparent or deep-color media makes full-color images more vivid. Clear ink printing enhances decorative effects such as mat, gloss and texture.

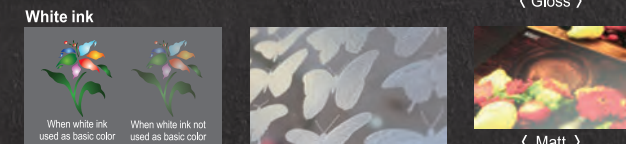

### Inkjet primer

A primer that enhances ink adhesion to glass, metal, or surface-treated material. Because primer coating simultaneously with color printing is possible, the primer can be placed only on those portions requiring it. Placing primer only where it is required without manual work is possible, making the most of the texture of raw material and realizing beautiful finishes.

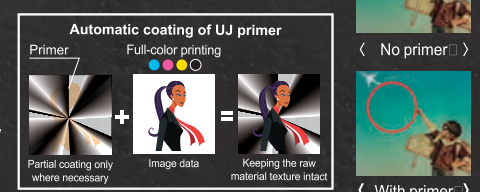

### Outdoor Advertisement



### Partition / Glass



### Point of Sale Signage



### Plywood



## Automation of printing processes

### Adaptable to "Mimaki Device Language (MDL)" to realize automation of printing processes

Using MDL commands allows you to automate printer control, job management, and workpiece conveying device operation from an external device

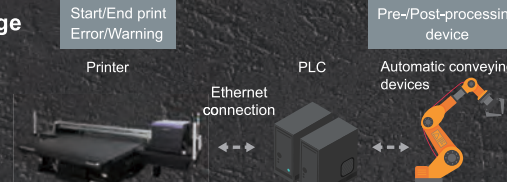

\*When using MDL commands, refer to the separate MDL commands manual included in the SDK.  
\*Please note that machine failures due to MDL commands may not be covered by our warranty.

## Combination of upgraded usability and functionality



Average 25% increase in RIP processing speed



### Mimaki Cloud Technology PICT

The printer's operating status and ink usage can be monitored even when the user is away from the printer. It supports planned operations and lets you see the operational status and performance of Mimaki printers, which can be useful for planning purposes. It also enables advanced scheduled maintenance and preparation for ink refills.



## Safety devices to prevent trouble

### Intrusion prevention sensor for the operating area



### Work status indicator light



### Media jam sensor

